

POPPY 1

www.sits.eu
MARCH 2015

ARMCHAIR

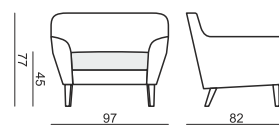

2 SEATER

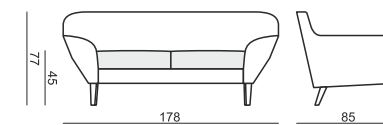

3 SEATER with 2 SEAT CUSHIONS

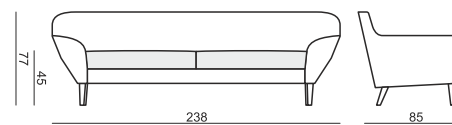

3 SEATER with 3 SEAT CUSHIONS

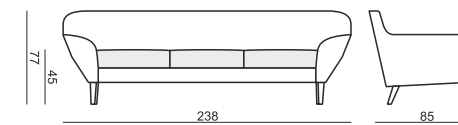

CHAISELONGUE FREESTANDING LEFT (or RIGHT)

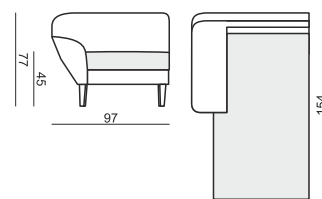

FOOTSTOOL

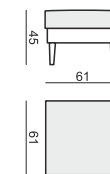

SQUARE CUSHIONS:

CUSHIONS 40x40

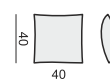

CUSHIONS 45x30 with buttons

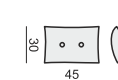

CUSHIONS 45x45 with button

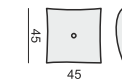

CUSHIONS 45x45

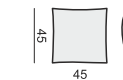

COMPOSITION EXAMPLE

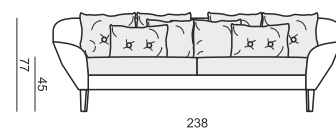

SUGGESTED MINIMUM NUMBER OF SQUARE CUSHIONS:

ARMCHAIR – 2 pcs, 2 SEATER – 4 pcs, 3 SEATER – 5 pcs, CHAISELONGUE – 2 pcs, SET 1 – 7 pcs, SET 2 – 6 pcs, SET 3 – 11 pcs, SET 4 – 10 pcs, SET 5 – 9 pcs

ARMCHAIR with lumbar cushion

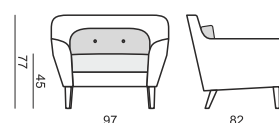

2 SEATER with lumbar cushions

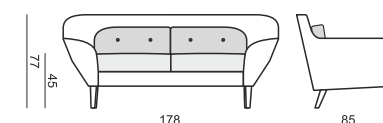

3 SEATER with 2 SEAT CUSHIONS with lumbar cushions

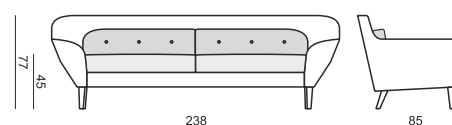

3 SEATER with 3 SEAT CUSHIONS with lumbar cushions

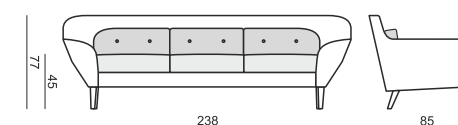

CHAISELONGUE FREESTANDING with lumbar cushion LEFT (or RIGHT)

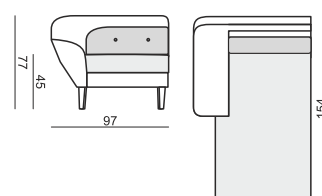

SITS reserves the right to change construction of products and components used due to improving durability of product and customer satisfaction without any further notice. Explicit ±2 cm tolerance of all elements sizes.

www.sits.eu
MARCH 2015

SET 1 RIGHT (or LEFT)

3 SEATER with 3 SEAT CUSHIONS LEFT (or RIGHT)
+ CHAISELONGUE RIGHT (or LEFT)

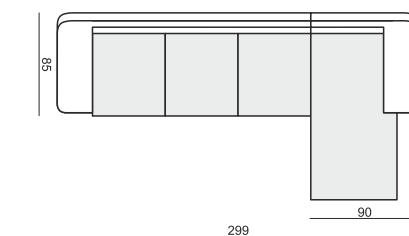

SET 2 RIGHT (or LEFT)

2 SEATER LEFT (or RIGHT)
+ CHAISELONGUE RIGHT (or LEFT)

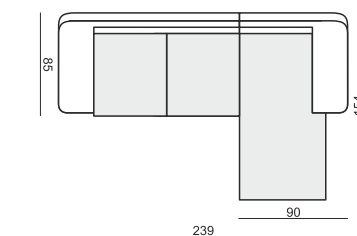

SET 3

3 SEATER with 2 SEAT CUSHIONS LEFT + CORNER 90°
+ 3 SEATER with 2 SEAT CUSHIONS RIGHT

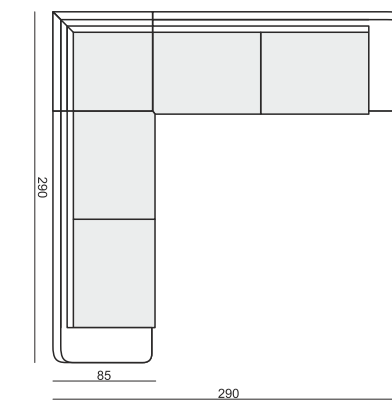

SET 4 LEFT (or RIGHT)

2 SEATER LEFT (or RIGHT) + CORNER 90°
+ 3 SEATER with 2 SEAT CUSHIONS RIGHT (or LEFT)

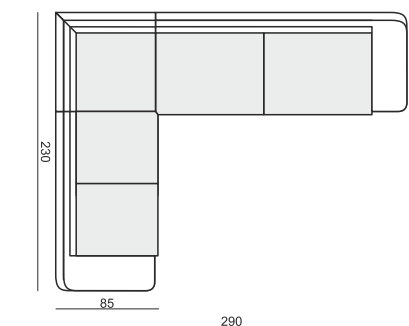

SET 5

2 SEATER LEFT + CORNER 90°
+ 2 SEATER RIGHT

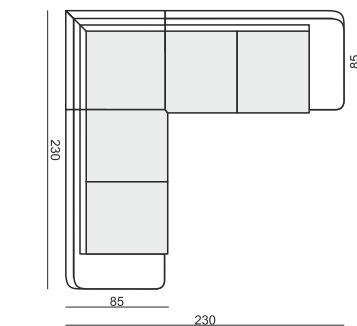

UPHOLSTERY

FABRIC: FC - fix cover

FEET

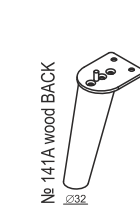

STANDARD COMFORT



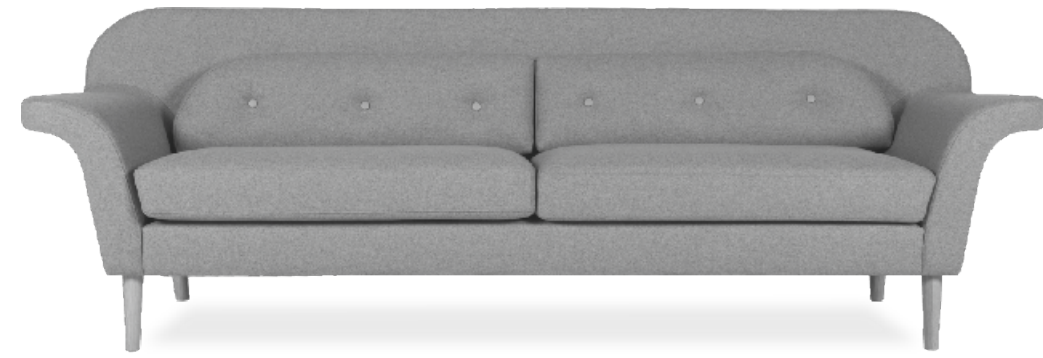

ARMCHAIR

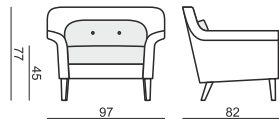

2 SEATER

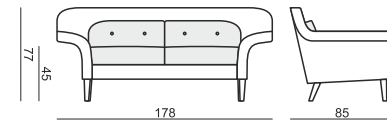

3 SEATER with 2 SEAT CUSHIONS

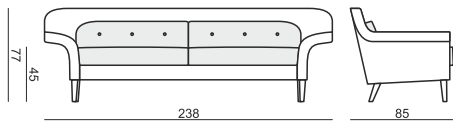

3 SEATER with 3 SEAT CUSHIONS

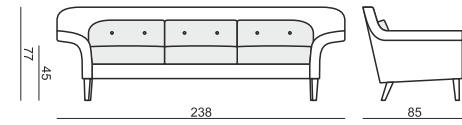

CHAISELONGUE FREESTANDING LEFT (or RIGHT)

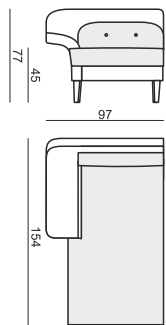

FOOTSTOOL

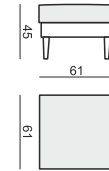

BED 140

(AVAILABLE FOR MATTRESS 140x200cm)

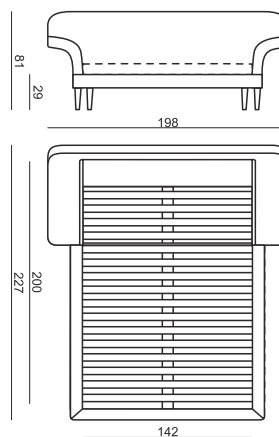

BED 160

(AVAILABLE FOR MATTRESS 160x200cm)

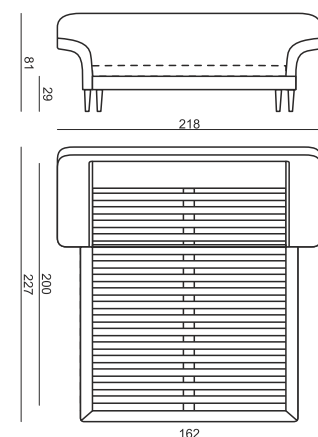

POPPY 2 IS ALSO AVAILABLE WITH SQUARE CUSHIONS

SQUARE CUSHIONS:

CUSHIONS 40x40

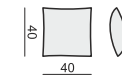

CUSHIONS 45x30 with buttons

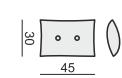

CUSHIONS 45x45 with button

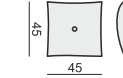

CUSHIONS 45x45

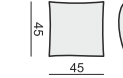

COMPOSITION EXAMPLE

3 SEATER with 2 SEAT CUSHIONS
(with 2x CUSHIONS 45x30 with buttons
+ 2x CUSHIONS 45x45 with button
+ 2x CUSHIONS 40x40 + 2x CUSHIONS 45x45)

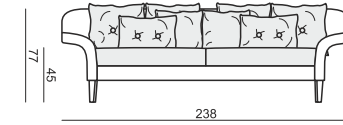

3 SEATER with 2 SEAT CUSHIONS
(with 6x CUSHIONS 45x45 with button)

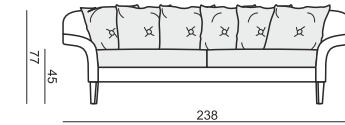

SUGGESTED MINIMUM NUMBER OF SQUARE CUSHIONS:
ARMCHAIR – 2 pcs, 2 SEATER – 4 pcs, 3 SEATER – 5 pcs, CHAISELONGUE – 2 pcs,
SET 1 – 7 pcs, SET 2 – 6 pcs, SET 3 – 11 pcs, SET 4 – 10 pcs, SET 5 – 9 pcs

SET 1 RIGHT (or LEFT)
3 SEATER with 3 SEAT CUSHIONS LEFT (or RIGHT)
+ CHAISELONGUE RIGHT (or LEFT)

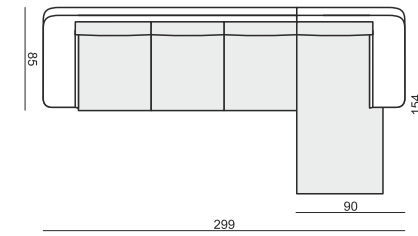

SET 2 RIGHT (or LEFT)
2 SEATER LEFT (or RIGHT)
+ CHAISELONGUE RIGHT (or LEFT)

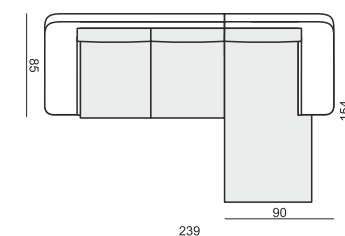

SET 3
3 SEATER with 2 SEAT CUSHIONS LEFT + CORNER 90°
+ 3 SEATER with 2 SEAT CUSHIONS RIGHT

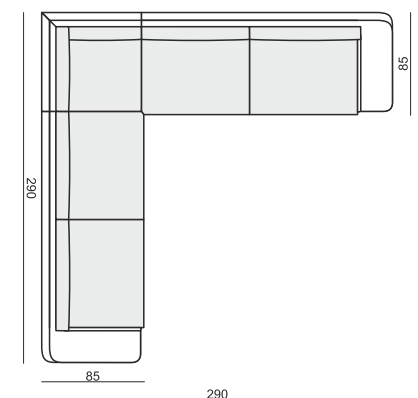

SET 4 LEFT (or RIGHT)
2 SEATER LEFT (or RIGHT) + CORNER 90°
+ 3 SEATER with 2 SEAT CUSHIONS RIGHT (or LEFT)

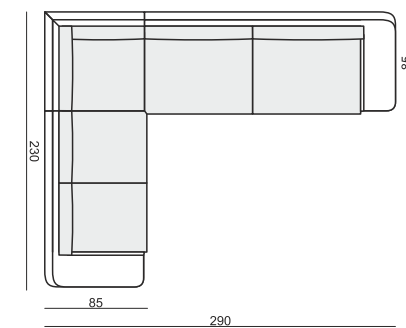

SET 5
2 SEATER LEFT + CORNER 90°
+ 2 SEATER RIGHT

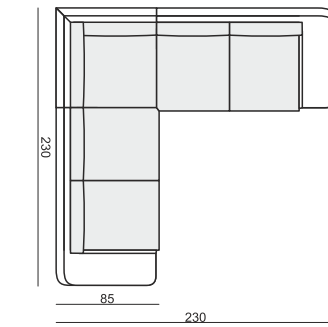

UPHOLSTERY

FABRIC: FC - fix cover

FEET

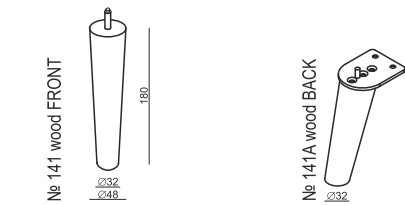

STANDARD COMFORT